

FX_{2N}

FX_{2N}-2DA SPECIAL FUNCTION BLOCK

USER'S GUIDE

JY992D74901D

This manual contains text, diagrams and explanations which will guide the reader in the correct installation and operation of the FX_{2N}-2DA special function block and should be read and understood before attempting to install or use the unit.

Further information can be found in the FX SERIES PROGRAMMING MANUAL(II), FX_{0N}/FX_{1N}/FX_{2N}/FX_{2NC} SERIES HARDWARE MANUAL of each PLC.

1. INTRODUCTION

The FX_{2N}-2DA type analog output block (hereafter referred to as the FX_{2N}-2DA) is used to convert a digital value of 12 bits into an analog output of two points (voltage and current output), and to forward the values to the Programmable Controller (hereafter referred to as a PLC).

FX_{2N}-2DA can be connected to the FX_{0N}, FX_{1N}, FX_{2N}, and the FX_{2NC} series Programmable Controllers.

- 1) The analog output is selected from the voltage or current output by the method of connecting wires. At this time, assume setting to be two channels common analog output.
- 2) The two analog output channels can accept outputs of 0 to 10V DC, 0 to 5V DC, or 4 to 20mA. (A mixture of voltage/current output is possible.)
- 3) Resolution is 2.5mV (0 to 10V DC) and 4μA (4 to 20mA).
- 4) The digital to analog conversion characteristics can be adjusted.
- 5) The block occupies 8 I/O points which can be allocated from either the inputs or outputs.
- 6) The data transfer with the PLC uses the FROM/TO instructions.

2. EXTERNAL DIMENSIONS AND PARTS

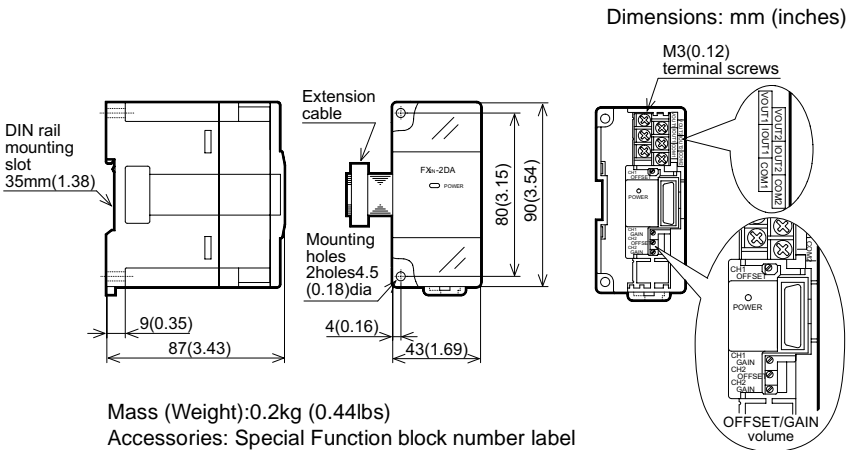

3. WIRING

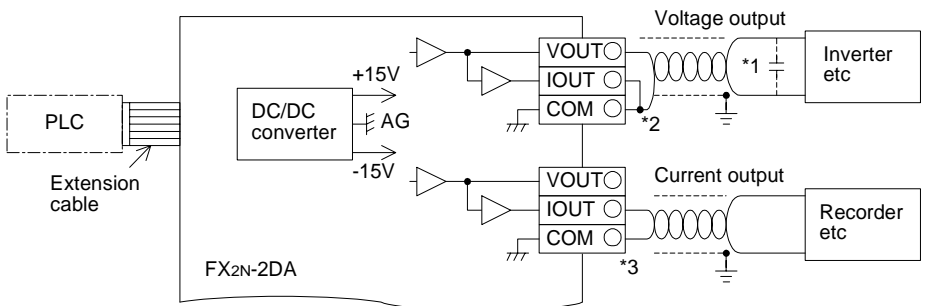

*1 Connect a 0.1 to 0.47 μF 25V DC capacitor respective to position *1 when there is voltage ripple in the voltage output or there is a lot of noise.

*2 For voltage output please short circuit IOUO and COM as shown in the diagram.

*3 Channel number enter ○.

4. CONNECTION WITH PROGRAMMABLE CONTROLLER

- 1) The FX2N-2DA and main unit are connected by a cable on the right of the main unit.
- 2) Up to 4 FX2N-2DA units can connect to the FX0N series PLC, up to 5 for FX1N, up to 8 for FX2N or, up to 4 for the FX2NC series PLC, all with powered extension units.
However the following limitation exists when the undermentioned special function blocks are connected.
 - FX2N: Main unit and powered extension units of 32 points I/O or less. Consumption current available for undermentioned special function blocks $\leq 190\text{mA}$
 - FX2N: Main unit and powered extension units of I/O 48 points or more. Consumption current available for undermentioned special function blocks $\leq 300\text{mA}$
 - FX2NC: Up to 4 undermentioned special function blocks can be connected regardless of the system I/O.
 - FX0N/1N: Main unit and powered extension units. Up to 2 undermentioned special function blocks can be connected regardless of the system I/O.

	FX2N-2DA	FX2N-2AD	FX0N-3A
Consumption current of 24V DC for one unit	85mA	50mA	90mA

The consumption of the above units is to be subtracted from the service power supply of the host PLC.

- 3) The blocks occupies 8 I/O points (the 8 points can be allocated from either inputs or outputs).
- 4) FX2N-2DA consumes 5V DC 30mA.
The total 5V consumption of all special function blocks connected to either an FX2N, FX2NC main unit or an FX2N extension unit must not exceed the 5V source capacity of the system.

5. SPECIFICATIONS

5.1 Environmental specification

Item	Content
Dielectric Withstand voltage	500V AC 1min (between analog output terminals and case)

Environmental specifications other than the above are the same as the main unit of the Programmable Controller. (Refer to the Hardware manual of the Programmable controller)

5.2 Power supply specification and others

Item	Content
Analog circuits	24V DC $\pm 10\%$ 85mA (Internal power supplied from the main unit)
Digital circuits	5V DC 30mA (Internal power supplied from the main unit)
Isolation	Photo-coupler isolation between analog and digital circuits. (No isolation between analog channels.)
Number of occupied I/O points	The blocks occupies either 8 input or output points. (Can be either inputs or outputs)

5.3 Defining gain and offset

Item	Voltage output	Current output
Range of analog output	At shipping, the unit is adjusted to a digital range of 0 to 4000 for an analog voltage output of 0 to 10V DC. When using an FX2N-2DA for current or differing voltage output except 0 to 10V DC, it is necessary to adjust the offset and gain.	
	0 to 10V DC, 0 to 5V DC (External load resistance 2K to 1M Ω)	4 to 20mA (External load resistance 400 Ω or less)
Digital input	12bit	
Resolution	2.5mV: 10V/4000(At shipment) Change depending on the output characteristic.	4 μ A: (20-4)A/4000 Change depending on the output characteristic.
Integrated accuracy	$\pm 0.1\text{V}$	
Processing time	4ms/1 channel (synchronized to be sequence program)	
Output characteristics	Analog value :0 to 10V Digital value :0 to 4000 } at shipment	
	If a digital source data of greater than 12 bits is used, only the lower 12 bits will be valid. Additional (upper) bits will be ignored Use a digital value within the range from 0 to 4095. The output characteristic can be set to each of the two channels.	

6. ALLOCATION OF BUFFER MEMORY (BFM)

6.1 Buffer memory

BFM number	b15 to b8	b7 to b3	b2	b1	b0
#0 to #15	Reserved				
#16	Reserved	Digital source data for output (8 bit)			
#17	Reserved		Lower data holding bit	CH1 D/A conversion beginning	CH2 D/A conversion beginning
#18 or more	Reserved				

BFM#16: The D/A conversion data of the channel specified with BFM#17 (digital value) is written.
The D/A data is written in binary in order of the lower 8bit and higher 4bit and divided into two portions.

BFM#17: b0...The D/A conversion of CH2 begins by changing of 1→0.
b1...The D/A conversion of CH1 begins by changing of 1→0.
b2...The lower eight bit data for the D/A conversion is held by changing of 1→0.

Write data in the above-mentioned buffer memory by "8. Program example".

7. ADJUSTMENT OF OFFSET AND GAIN

7.1 Change in output characteristic

At shipment, 0 to 4000 range is selected for 0 to 10V DC output.

When using an FX2N-2DA for current or differing voltage output except 0 to 10V DC, it is necessary to readjust the offset and gain.

The output characteristic can be set for each of the two channels.

Set analog values within the range specified in the table below when changing the output characteristic.

Range of output characteristic

	Voltage output	Current output
Analog value when digital value is 0	0 to 1V	4mA
Analog value when digital value is 4000	5 to 10V	20mA

Resolution changes depending on the set value when the output characteristic changes accordingly.

Example: Resolution becomes $(5 - 0V)/4000 = 1.25mV$ at voltage output 0 to 5V/0 to 4000.

Integrated accuracy does not change. (Voltage output: $\pm 0.1V$, Current output: $\pm 0.16mA$)

The adjustment of the offset and gain values sets a digital equivalent to the analog data.

(The "POT" requires 18 revolutions to move between MIN and MAX setting.)

Voltage output

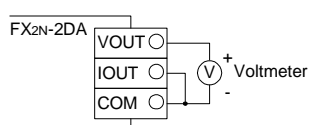

Current output

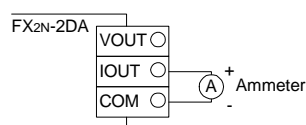

Volume *1

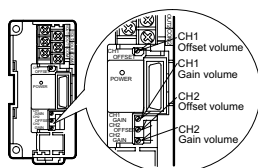

*1 The analog value increases if the volume is turned clockwise.

7.1.1 Adjustment of gain

The gain value can be set to an arbitrary digital value.

However, using the maximum of 12bit resolution provides the user with a full scale analog value.

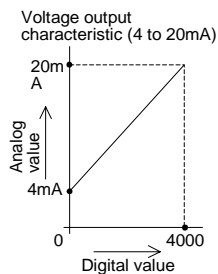
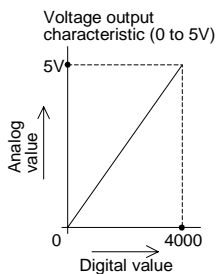
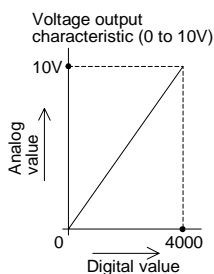

7.1.2 Adjustment of offset

The offset value in the case of voltage output is 0V. The offset value in the case of current output is 4mA.

However, the offset value can be minutely adjusted if necessary. Set the following when minute adjustments are necessary.

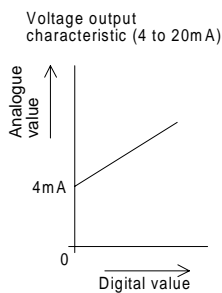
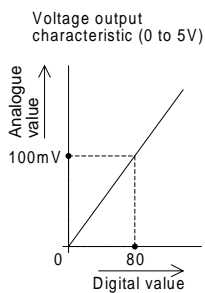
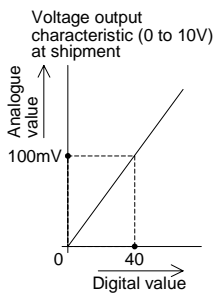

For instance, when a digital range of 0 to 4000 is used with the analog range of 0 to 10V, a digital value of 40 is equal to an analog output of 100mV, $(40 \times 10V/4000 \text{ digital points})$. When a digital range of 0 to 4000 is used with the analog range of 4 to 20mA, a digital value of 0 is equal to an analog output of 4mA.

- 1) Adjust the offset and gain respectively for CH1 and CH2.
- 2) Repeat offset and gain adjustments until a stable value is obtained.
- 3) Adjust the gain before the offset.

8. PROGRAM EXAMPLE

The following program examples (8.1 and 8.2) are formula circuits.

The device numbers that have been underlined can be assigned by the user during programming.

8.1 At connection to FX0N series PLC

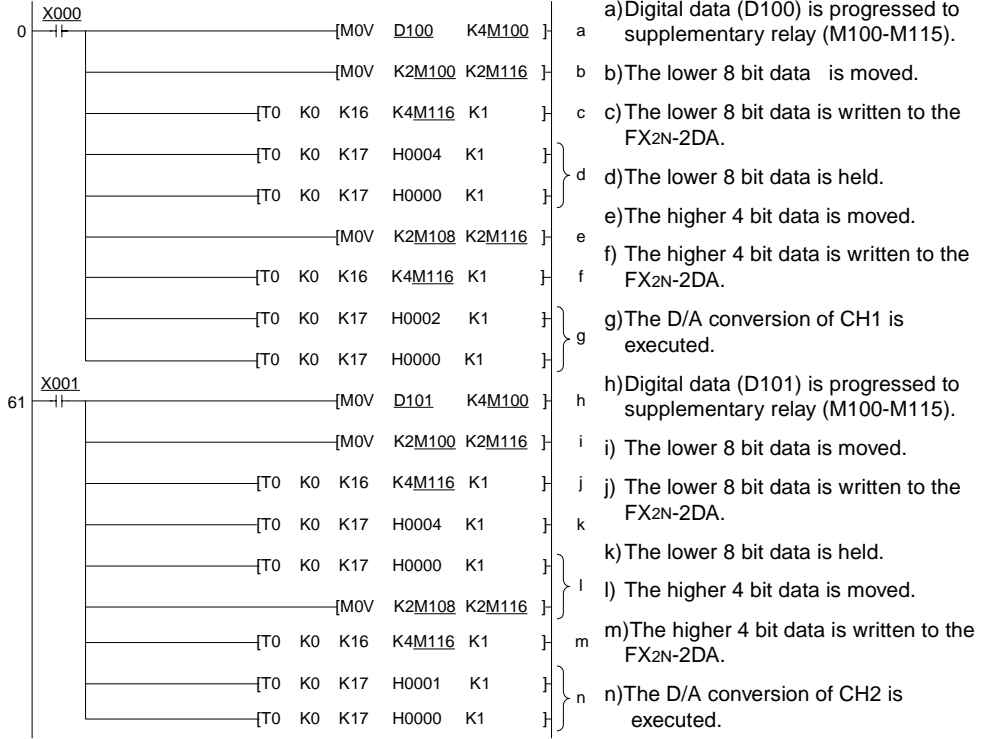

Digital to analog conversion execution input of CH1 :X000

Digital to analog conversion execution input of CH2 :X001

At the same time X000 and X001 can be turned ON.

D/A output data CH1:D100 (Replace with auxiliary relay M100 to M131. Assign these numbers only once)

D/A output data CH2:D101 (Replace with auxiliary relay M100 to M131. Assign these numbers only once)

Processing time: 4ms / 1 channel

(Time until FX2N-2DA outputs analog value after turning on X000 and X001.)

8.2 At connection to FX1N, FX2N or FX2N series PLC

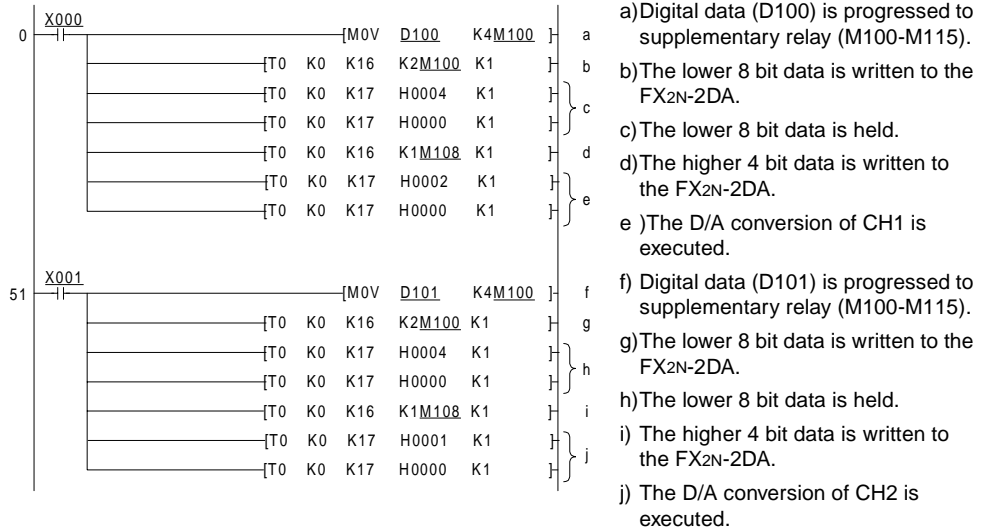

Digital to analog conversion execution input of CH1 :X000

Digital to analog conversion execution input of CH2 :X001

At the same time X000 and X001 can be turned ON.

D/A output data CH1:D100 (Replace with auxiliary relay M100 to M115. Assign these numbers only once)

D/A output data CH2 :D101 (Replace with auxiliary relay M100 to M115. Assign these numbers only once)

Processing time:4ms / 1 channel

(Time until FX2N-2DA outputs analog value after turning on X000 and X001.)

8.3 Connection to FX2N (V3.00 or later) or FX2N (V3.00 or later) series PLC

Please use FNC 177 (WR3A).

Refer to FX series Programming Manual II.

9. NOTES IN DRIVE

- 1) Confirm whether the output wiring of FX2N-2DA and the connection of the extension cable are correctly done.
- 2) Confirm whether the "4. Connection with programmable controller" condition is satisfied.
- 3) When shipped from the factory, the output characteristic is adjusted to 0 to 10V DC.
If a different output characteristic is desired, please adjust as required.
- 4) The mixture use for the voltage output/the current output is possible.

10. ERROR CHECK

Confirm the following items when it seems that the FX2N-2DA does not operate correctly.

- 1) Confirm the state of POWER LED.
Lit :The extension cable is correctly connected.
Turn off or blinks :Confirm the proper connection of the extension cable.
- 2) Confirm external wiring per section "3. WIRING"
- 3) Confirm whether the load resistance of the connected equipment corresponds to the specification of the FX2N-2DA.
- 4) Confirm the Voltage and Current Output values with a voltmeter and an ammeter. Confirm the digital to analog conversion from the output characteristic. Readjust the offset and gain per "7. ADJUSTMENT OF OFFSET AND GAIN". The output characteristic when shipped from the factory is 0 to 10V DC.

Guidelines for the safety of the user and protection of the FX2N-2DA SPECIAL FUNCTION BLOCK

- This manual has been written to be used by trained and competent personnel. This is defined by the European directives for machinery, low voltage and EMC.
- If in doubt at any stage during the installation of the FX2N-2DA always consult a professional electrical engineer who is qualified and trained to the local and national standards. If in doubt about the operation or use of the FX2N-2DA please consult the nearest Mitsubishi Electric distributor.
- Under no circumstances will Mitsubishi Electric be liable or responsible for any consequential damage that may arise as a result of the installation or use of this equipment.
- All examples and diagrams shown in this manual are intended only as an aid to understanding the text, not to guarantee operation. Mitsubishi Electric will accept no responsibility for actual use of the product based on these illustrative examples.
- Owing to the very great variety in possible application of this equipment, you must satisfy yourself as to its suitability for your specific application.

Manual number : JY992D74901

Manual revision : D

Date : SEPTEMBER 2002



HEAD OFFICE : MITSUBISHI DENKI BLDG MARUNOUTI TOKYO 100-8310 TELEX : J24532 CABLE MELCO TOKYO
HIMEJI WORKS : 840, CHIYODA CHO, HIMEJI, JAPAN

FX_{2N}

FX_{2N}-2DA SPECIAL FUNCTIONBLOCK

USER'S GUIDE

JY992D74901D

This manual contains text, diagrams and explanations which will guide the reader in the correct installation and operation of the FX_{2N}-2DA special function block and should be read and understood before attempting to install or use the unit.

Further information can be found in the FX SERIES PROGRAMMING MANUAL(II), FX_{0N}/FX_{1N}/FX_{2N}/FX_{2NC} SERIES HARDWARE MANUAL of each PLC.

1. INTRODUCTION

The FX_{2N}-2DA type analog output block (hereafter referred to as the FX_{2N}-2DA) is used to convert a digital value of 12 bits into an analog output of two points (voltage and current output), and to forward the values to the Programmable Controller (hereafter referred to as a PLC).

FX_{2N}-2DA can be connected to the FX_{0N}, FX_{1N}, FX_{2N}, and the FX_{2NC} series Programmable Controllers.

- 1) The analog output is selected from the voltage or current output by the method of connecting wires. At this time, assume setting to be two channels common analog output.
- 2) The two analog output channels can accept outputs of 0 to 10V DC, 0 to 5V DC, or 4 to 20mA. (A mixture of voltage/current output is possible.)
- 3) Resolution is 2.5mV (0 to 10V DC) and 4μA(4 to 20mA).
- 4) The digital to analog conversion characteristics can be adjusted.
- 5) The block occupies 8 I/O points which can be allocated from either the inputs or outputs.
- 6) The data transfer with the PLC uses the FROM/TO instructions.

2. EXTERNAL DIMENSIONS AND PARTS

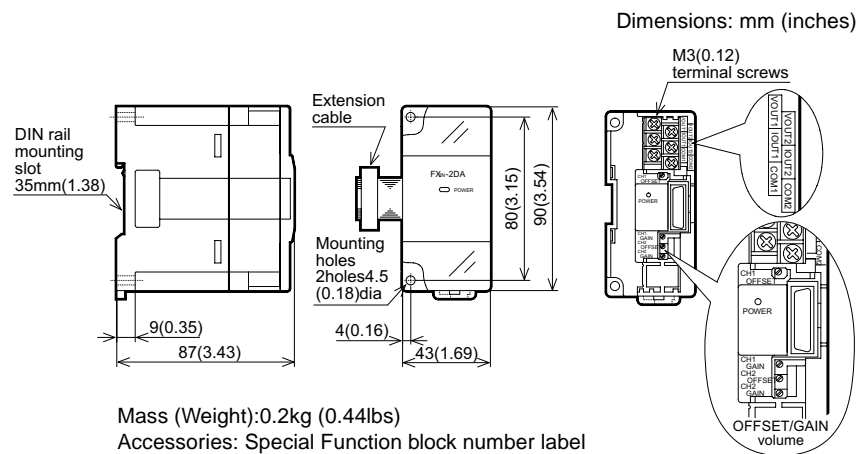

3. WIRING

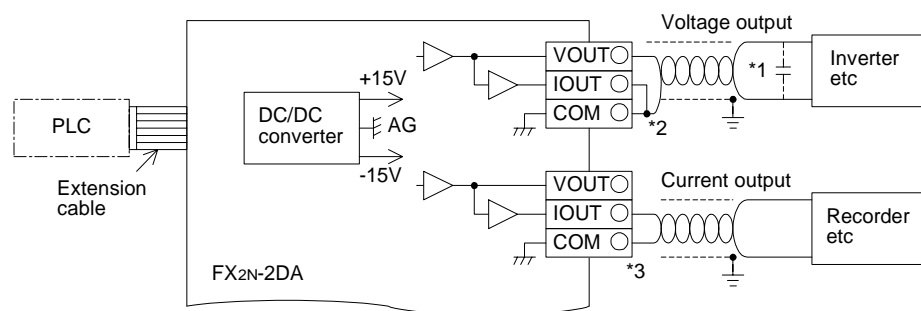

*1 Connect a 0.1 to 0.47 μF 25V DC capacitor respective to position *1 when there is voltage ripple in the voltage output or there is a lot of noise.

*2 For voltage output please short circuit IOUT and COM as shown in the diagram.

*3 Channel number enter ○.

4. CONNECTION WITH PROGRAMMABLE CONTROLLER

- 1) The FX_{2N}-2DA and main unit are connected by a cable on the right of the main unit.
 - 2) Up to 4 FX_{2N}-2DA units can connect to the FX_{0N} series PLC, up to 5 for FX_{1N}, up to 8 for FX_{2N} or, up to 4 for the FX_{2NC} series PLC, all with powered extension units. However the following limitation exists when the undermentioned special function blocks are connected.
- FX_{2N}: Main unit and powered extension units of 32 points I/O or less. Consumption current available for undermentioned special function blocks ≤ 190mA
- FX_{2N}: Main unit and powered extension units of I/O 48 points or more. Consumption current available for undermentioned special function blocks ≤ 300mA
- FX_{2NC}: Up to 4 undermentioned special function blocks can be connected regardless of the system I/O.
- FX_{0N/1N}: Main unit and powered extension units. Up to 2 undermentioned special function blocks can be connected regardless of the system I/O.

	FX _{2N} -2DA	FX _{2N} -2AD	FX _{0N} -3A
Consumption current of 24V DC for one unit	85mA	50mA	90mA

The consumption of the above units is to be subtracted from the service power supply of the host PLC.

- 3) The blocks occupies 8 I/O points (the 8 points can be allocated from either inputs or outputs).
- 4) FX_{2N}-2DA consumes 5V DC 30mA. The total 5V consumption of all special function blocks connected to either an FX_{2N}, FX_{2NC} main unit or an FX_{2N} extension unit must not exceed the 5V source capacity of the system.

5. SPECIFICATIONS

5.1 Environmental specification

Item	Content
Directric Withstand voltage	500V AC 1min (between analog output terminals and case)

Environmental specifications other than the above are the same as the main unit of the Programmable Controller. (Refer to the Hardware manual of the Programmable controller)

5.2 Power supply specification and others

Item	Content
Analog circuits	24V DC ±10% 85mA (Internal power supplied from the main unit)
Digital circuits	5V DC 30mA (Internal power supplied from the main unit)
Isolation	Photo-coupler isolation between analog and digital circuits. (No isolation between analog channels.)
Number of occupied I/O points	The blocks occupies either 8 input or output points. (Can be either inputs or outputs)

5.3 Defining gain and offset

Item	Voltage output	Current output
Range of analog output	At shipping, the unit is adjusted to a digital range of 0 to 4000 for an analog voltage output of 0 to 10V DC. When using an FX _{2N} -2DA for current or differing voltage output except 0 to 10V DC, it is necessary to adjust the offset and gain. 0 to 10V DC, 0 to 5V DC (External load resistance 2K to 1MΩ)	4 to 20mA (External load resistance 400Ω or less)
Digital input	12bit	
Resolution	2.5mV: 10V/4000(At shipment) Change depending on the output characteristic.	4μA: (20-4)A/4000 Change depending on the output characteristic.
Integrated accuracy	± 0.1V	± 0.16mA
Processing time	4ms/1 channel (synchronized to be sequence program)	
Output characteristics	<p>Analog value : 0 to 10V Digital value : 0 to 4000] at shipment</p>	<p>Analog value : 4 to 20mA Digital value : 0 to 4000</p>
	If a digital source data of greater than 12 bits is used, only the lower 12 bits will be valid. Additional (upper) bits will be ignored. Use a digital value within the range from 0 to 4095. The output characteristic can be set to each of the two channels.	

6. ALLOCATION OF BUFFER MEMORY (BFM)

6.1 Buffer memory

BFM number	b15 to b8	b7 to b3	b2	b1	b0
#0 to #15	Reserved				
#16	Reserved	Digital source data for output (8 bit)			
#17	Reserved		Lower data holding bit	CH1 D/A conversion beginning	CH2 D/A conversion beginning
#18 or more	Reserved				

BFM#16: The D/A conversion data of the channel specified with BFM#17 (digital value) is written. The D/A data is written in binary in order of the lower 8bit and higher 4bit and divided into two portions.

BFM#17: b0...The D/A conversion of CH2 begins by changing of 1→0.
b1...The D/A conversion of CH1 begins by changing of 1→0.
b2...The lower eight bit data for the D/A conversion is held by changing of 1→0.

Write data in the above-mentioned buffer memory by "8. Program example".

7. ADJUSTMENT OF OFFSET AND GAIN

7.1 Change in output characteristic

At shipment, 0 to 4000 range is selected for 0 to 10V DC output. When using an FX2N-2DA for current or differing voltage output except 0 to 10V DC, it is necessary to readjust the offset and gain. The output characteristic can be set for each of the two channels. Set analog values within the range specified in the table below when changing the output characteristic.

Range of output characteristic

	Voltage output	Current output
Analog value when digital value is 0	0 to 1V	4mA
Analog value when digital value is 4000	5 to 10V	20mA

Resolution changes depending on the set value when the output characteristic changes accordingly. Example: Resolution becomes $(5 - 0V)/4000 = 1.25mV$ at voltage output 0 to 5V/0 to 4000. Integrated accuracy does not change. (Voltage output: $\pm 0.1V$, Current output: $\pm 0.16mA$)

The adjustment of the offset and gain values sets a digital equivalent to the analog data. (The "POT" requires 18 revolutions to move between MIN and MAX setting.)

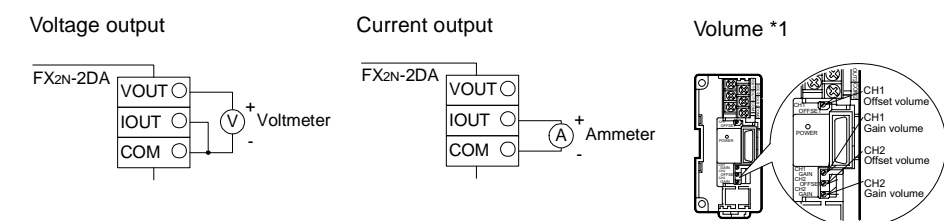

*1 The analog value increases if the volume is turned clockwise.

7.1.1 Adjustment of gain

The gain value can be set to an arbitrary digital value. However, using the maximum of 12bit resolution provides the user with a full scale analog value.

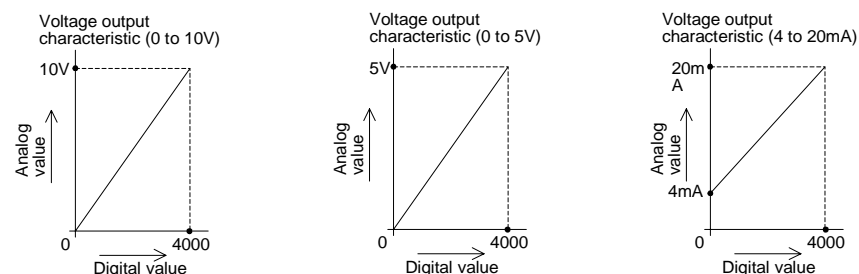

7.1.2 Adjustment of offset

The offset value in the case of voltage output is 0V. The offset value in the case of current output is 4mA. However, the offset value can be minutely adjusted if necessary. Set the following when minute adjustments are necessary.

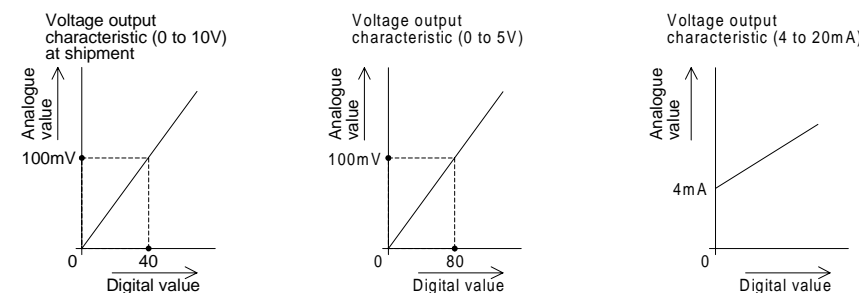

For instance, when a digital range of 0 to 4000 is used with the analog range of 0 to 10V, a digital value of 40 is equal to an analog output of 100mV, $(40 \times 10V/4000 \text{ digital points})$. When a digital range of 0 to 4000 is used with the analog range of 4 to 20mA, a digital value of 0 is equal to an analog output of 4mA.

- 1) Adjust the offset and gain respectively for CH1 and CH2.
- 2) Repeat offset and gain adjustments until a stable value is obtained.
- 3) Adjust the gain before the offset.

8. PROGRAM EXAMPLE

The following program examples (8.1 and 8.2) are formula circuits. The device numbers that have been underlined can be assigned by the user during programming.

8.1 At connection to FX0N series PLC

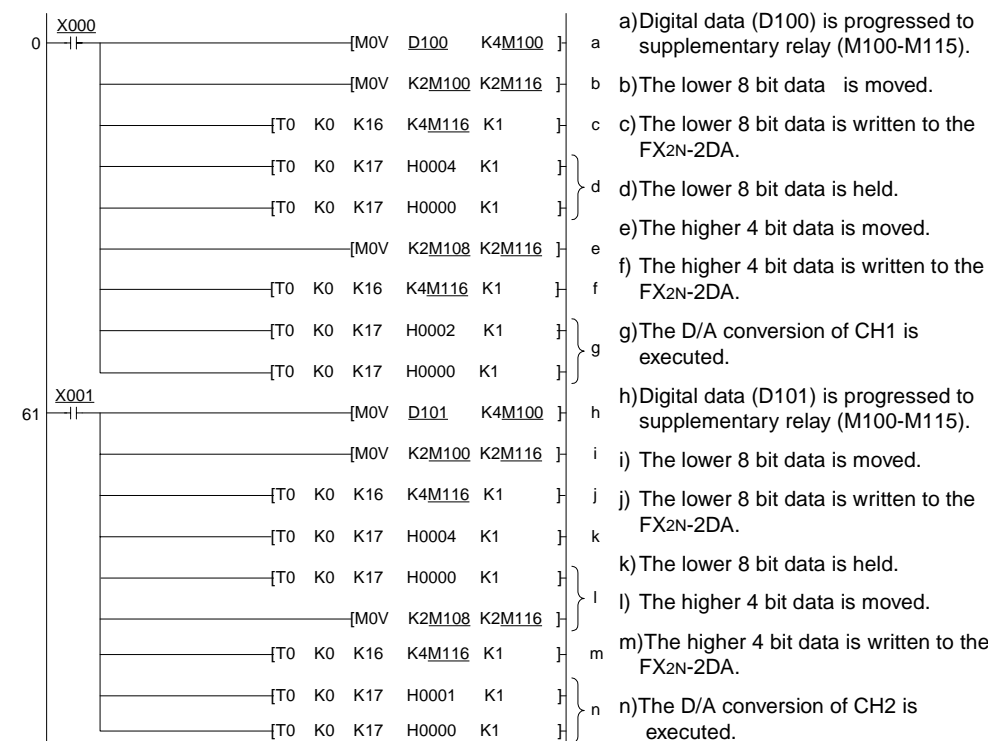

Digital to analog conversion execution input of CH1 :X000
Digital to analog conversion execution input of CH2 :X001
At the same time X000 and X001 can be turned ON.
D/A output data CH1:D100 (Replace with auxiliary relay M100 to M131. Assign these numbers only once)
D/A output data CH2:D101 (Replace with auxiliary relay M100 to M131. Assign these numbers only once)

Processing time: 4ms / 1 channel
(Time until FX2N-2DA outputs analog value after turning on X000 and X001.)

8.2 At connection to FX1N, FX2N or FX2N series PLC

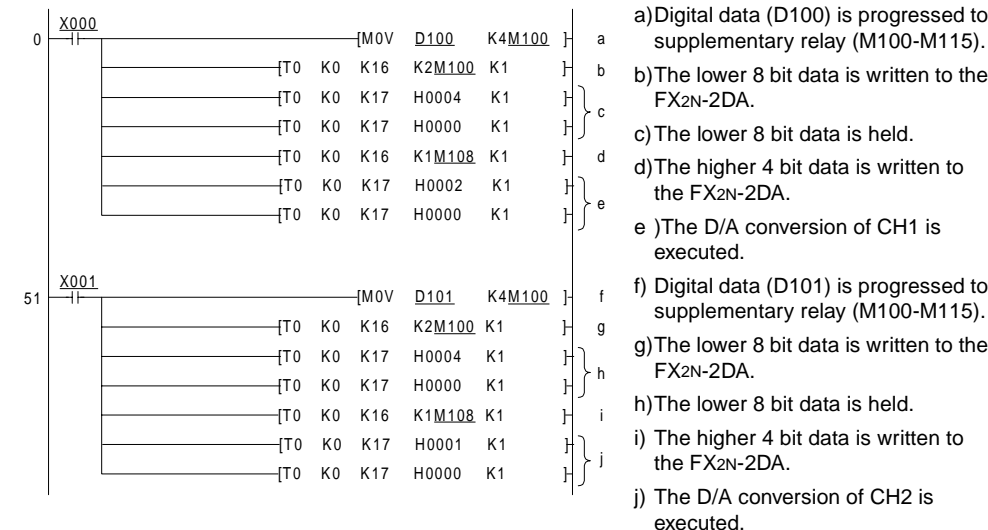

Digital to analog conversion execution input of CH1 :X000
Digital to analog conversion execution input of CH2 :X001
At the same time X000 and X001 can be turned ON.
D/A output data CH1:D100 (Replace with auxiliary relay M100 to M115. Assign these numbers only once)
D/A output data CH2 :D101 (Replace with auxiliary relay M100 to M115. Assign these numbers only once)

Processing time:4ms / 1 channel
(Time until FX2N-2DA outputs analog value after turning on X000 and X001.)

8.3 Connection to FX2N (V3.00 or later) or FX2N (V3.00 or later) series PLC

Please use FNC 177 (WR3A).
Refer to FX series Programming Manual II.

9. NOTES IN DRIVE

- 1) Confirm whether the output wiring of FX2N-2DA and the connection of the extension cable are correctly done.
- 2) Confirm whether the "4. Connection with programmable controller" condition is satisfied.
- 3) When shipped from the factory, the output characteristic is adjusted to 0 to 10V DC. If a different output characteristic is desired, please adjust as required.
- 4) The mixture use for the voltage output/the current output is possible.

10. ERROR CHECK

Confirm the following items when it seems that the FX2N-2DA does not operate correctly.

- 1) Confirm the state of POWER LED.
Lit :The extension cable is correctly connected.
Turn off or blinks :Confirm the proper connection of the extension cable.
- 2) Confirm external wiring per section "3. WIRING"
- 3) Confirm whether the load resistance of the connected equipment corresponds to the specification of the FX2N-2DA.
- 4) Confirm the Voltage and Current Output values with a voltmeter and an ammeter. Confirm the digital to analog conversion from the output characteristic. Readjust the offset and gain per "7. ADJUSTMENT OF OFFSET AND GAIN". The output characteristic when shipped from the factory is 0 to 10V DC.

Guidelines for the safety of the user and protection of the FX2N-2DA SPECIAL FUNCTION BLOCK

- This manual has been written to be used by trained and competent personnel. This is defined by the European directives for machinery, low voltage and EMC.
- If in doubt at any stage during the installation of the FX2N-2DA always consult a professional electrical engineer who is qualified and trained to the local and national standards. If in doubt about the operation or use of the FX2N-2DA please consult the nearest Mitsubishi Electric distributor.
- Under no circumstances will Mitsubishi Electric be liable or responsible for any consequential damage that may arise as a result of the installation or use of this equipment.
- All examples and diagrams shown in this manual are intended only as an aid to understanding the text, not to guarantee operation. Mitsubishi Electric will accept no responsibility for actual use of the product based on these illustrative examples.
- Owing to the very great variety in possible application of this equipment, you must satisfy yourself as to its suitability for your specific application.

Manual number : JY992D74901

Manual revision : D

Date : SEPTEMBER 2002

MITSUBISHI ELECTRIC CORPORATION

HEAD OFFICE : MITSUBISHI DENKI BLDG MARUNOUCHI TOKYO 100-8310 TELEX : J24532 CABLE MELCO TOKYO
HIMEJI WORKS : 840, CHIYODA CHO, HIMEJI, JAPAN

JY992D74901D

Effective Sep. 2002
Specifications are subject to
change without notice